

Three-phase autotransformers for dry type neutral generator, with anti-flash varnish finished in IP54/65 metal enclosure with protection for outdoor installation.



## Technical characteristics

Rating	8 kVA
Input voltage	400 V
Output voltage	NEUTRAL
Frequency	50/60 Hz
Connection group	ZN0
Cover	Metal enclosure RAL 7035 (cat. C4 ISO 12994-2)
Protection degree	IP-65 / IK-10
Cooling	ANAN
Ambient temperature	45 °C
Temperature rise	Class F - 155°C
Insulation	Class H - 180°C
Windings	Class HC - 200 °C
Test voltage	3 kV (1 min, 50 Hz)
Standards	IEC/EN/UNE-EN 61558, CE
Includes	Silent blocks
Weight	67 kg

## Dimensions

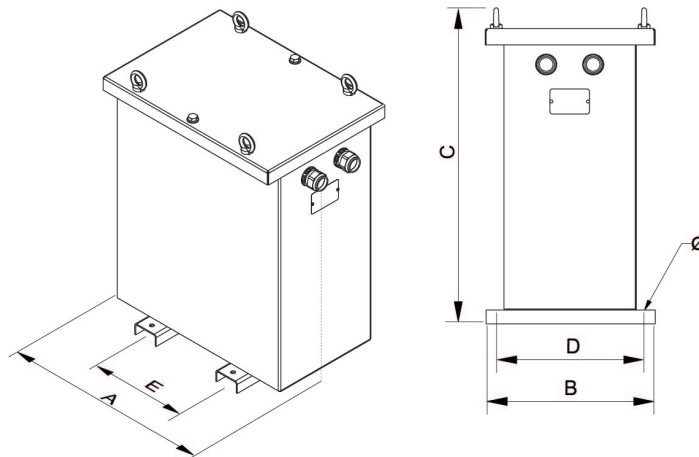

Dimensions (AxBxCxDxE): 510x362x689x320x250 mm 11Ø

## Electrical connection

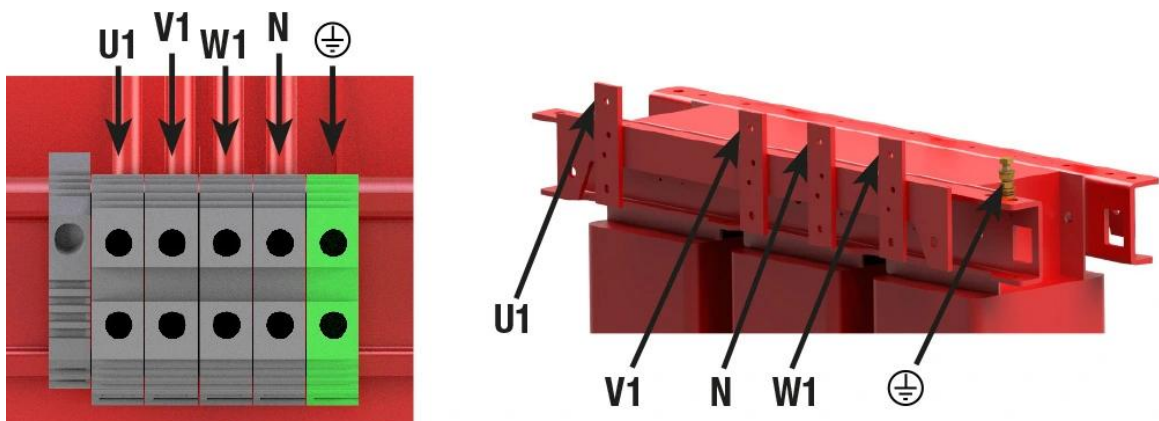

Three-phase autotransformers for dry type neutral generator, with anti-flash varnish finished in IP54/65 metal enclosure with protection for outdoor installation.

## Features

---

Dry type autotransformer

Anti-flash varnish finish, offering:

- Protection against corrosive environments
- Increase of electrical isolation
- High compression capacity
- Reduction of noise level
- Increase of product's lifespan

IP-65 up to 63kVA and IP-54 as from 80kVA (for IP-65 degree consult us) metallic box enclosure painted with polyester resin RAL 7035 (cat. C4 ISO 12994-2)

Safety class I

Includes cable glands, silent-blocks and stainless steel lifting eyebolts from 12,5 kVA

Possibility of tailor-made manufacturing

## Downloads

---