

Galvanically isolated non-homopolar harmonic compensators (5th, 7th, 17th and 19th) and two outputs supplying 50% of the load for dry type industrial installations, finished in anti-flash varnished in IP23 metal enclosure with protection to prevent direct contact with electrical parts.



## Technical characteristics

Rating	63 kVA
Line voltage	400 V
Frequency	50/60 Hz
Protection degree	IP-23 / IK-08
Cooling	ANAN
Ambient temperature	45 °C
Temperature rise	Class H - 180°C
Insulation	Class H - 180°C
Windings	Class HC - 200 °C
Test voltage	3 kV (1 min, 50 Hz)
Standards	IEC/EN/UNE-EN 60076 61000-3-2/4, CE y IEE 519, CE
Weight	405 kg

## Dimensions

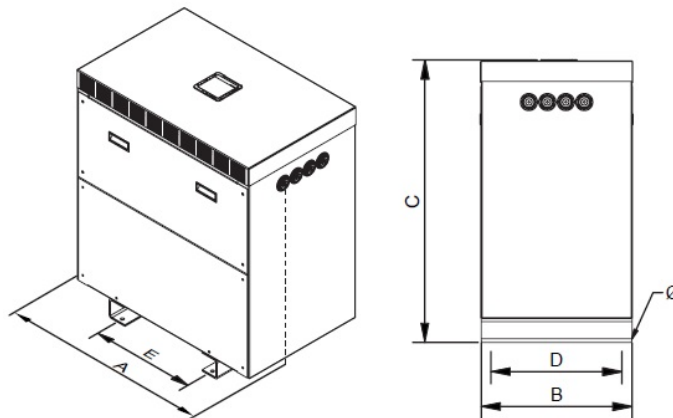

Dimensions (AxBxCxDxE): 795x550x970x500x415 mm 12Ø

Galvanically isolated non-homopolar harmonic compensators (5th, 7th, 17th and 19th) and two outputs supplying 50% of the load for dry type industrial installations, finished in anti-flash varnished in IP23 metal enclosure with protection to prevent direct contact with electrical parts.

## Features

---

### Compensator

Anti-flash varnish finish, offering:

- Protection against corrosive environments
- Increase of electrical isolation
- High compression capacity
- Reduction of noise level
- Increase of product's lifespan

Metalic box IP-23 enclosure painted with epoxy polyester resin RAL 7035 (cat. C2 ISO 12994-2)

Safety class I

Includes lifting eyebolts

Possibility of tailor-made manufacturing

Technical remarks:

- Compensator for homopolar and no homopolar harmonic filtering
- 50% Sn for each secondary
- For more information check our compensators' application guide

## Downloads

---