

Three-phase blocking reactors with bimetal over-temperature protection, 5.67% filtering factor, resin finished and anti-flash varnished.

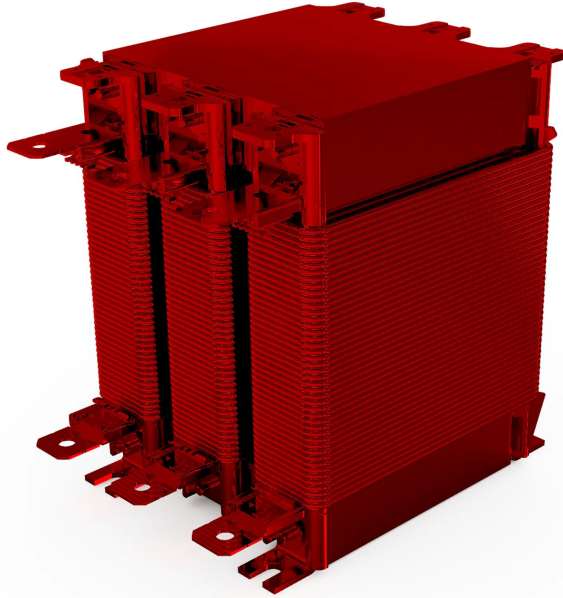

Technical characteristics

Line voltage	400 V
Capacitor rating	40 kvar (440 V, 50 Hz)
Effective rating	34,9 kvar
Rated current	50,4 A
Reactor	0,8734 mH (50 Hz)
Inductance tolerance	3%
Resonance frequency	210 Hz (p 5,67%)
Harmonic currents	I3 - 6%, I5 - 56%, I7 - 19%
Thermal overload factor	0,05
Frequency	50 Hz
Protection degree	IP-00
Cooling	AN
Ambient temperature	45°C
Temperature rise	Class F - 155°C
Insulation	Clase H - 180 °C
Windings	Class HC - 200 °C
Test voltage	3 kV (1 min, 50 Hz)
Includes	Bimetal thermal protection
Standards	IEC/EN/UNE-EN 60076-6, CE
Mounting	Screws
Weight	20,9 kg

Dimensions

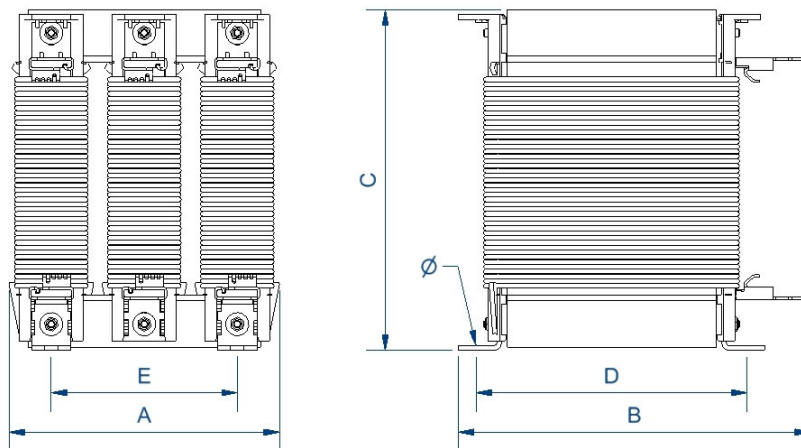

Dimensions (AxBxCxDxE): 180x205x220x150x120 mm 9Ø

Three-phase blocking reactors with bimetal over-temperature protection, 5.67% filtering factor, resin finished and anti-flash varnished.

Features

Reactor

Anti-flash varnish finish, offering:

- Protection against corrosive environments
- Increase of electrical isolation
- High compression capacity
- Reduction of noise level
- Increase of product's lifespan

Safety class I

Includes thermal protection against overtemperatures

Possibility of tailor-made manufacturing

Technical remarks about the use of detuned reactors:

- They avoid resonance between the feeding transformer's inductance and the capacitance of capacitors' bank
- They eliminate overvoltages and overcurrents either from the transformer and from the capacitors' bank
- They protect capacitors against harmonics avoiding early aging
- They limit conection peaks of the capacitors' bank increasing their lifespan and reducing microcuts in the feeding voltage

Downloads
