

Single-phase isolation transformers for medical use under IEC/EN 61558-2-15 standard, dry type finished in anti-flash varnished in IP23 metal enclosure with protection to prevent direct contact with electrical parts.



Technical characteristics

Rating	8000 VA
Input voltage	230 V
Output voltage	115-0-115 V
Frequency	50/60 Hz
Protection degree	IP-23 / IK-08
Cover	Metal enclosure RAL 7035 (cat. C3 ISO 12994-2)
Cooling	ANAN
Ambient temperature	45 °C
Inrush current	< 8In
Temperature rise	Class F - 155°C
Insulation	Class H - 180°C
Windings	Class HC - 200 °C
Test voltage	3,5 kV (1 min, 50 Hz)
No load voltage	< 3 %
Leakage current	0,5 mA (sec-earth)
Standards	IEC/EN/UNE-EN 61558-2-15, CE
Includes	Electrostatic screen between 1º & 2º and bimetal thermal protection
Weight	65 kg

Electric scheme

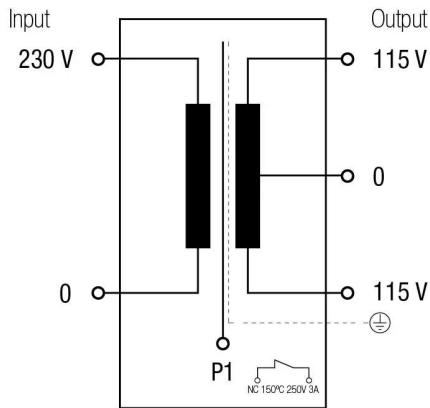

*Klixon 150°C 250 V 3 A included

Dimensions

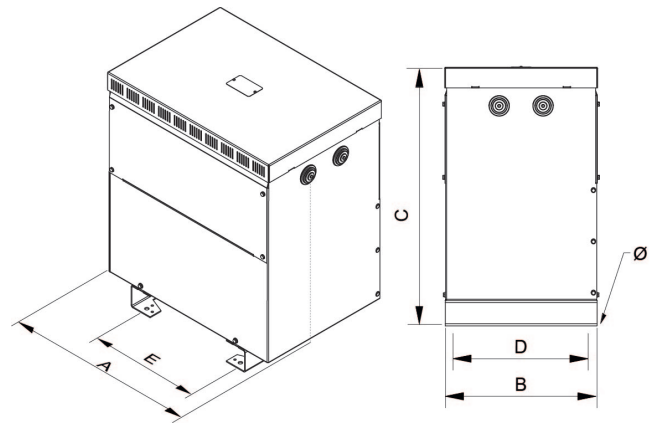

Dimensions (AxBxCxDxE): 528x418x644x375x345 mm 12Ø

Electrical connection

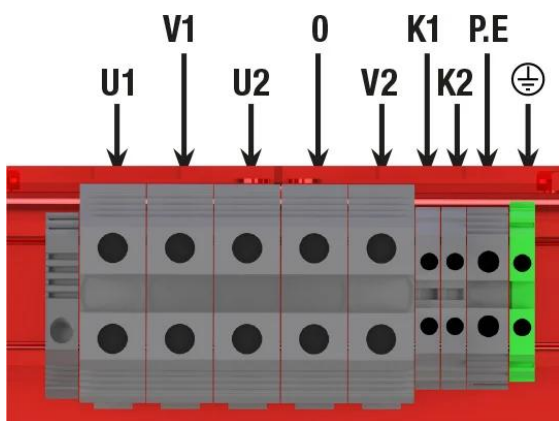

- U1 = 0
- V1 = 230 V
- U2 = 115 V
- V2 = 115 V
- K1 = termostato klixon 150°C para 1ª bobina
- K2 = termostato klixon 150°C para 2ª bobina
- P.E = electrostatic shield

Single-phase isolation transformers for medical use under IEC/EN 61558-2-15 standard, dry type finished in anti-flash varnished in IP23 metal enclosure with protection to prevent direct contact with electrical parts.

Features

Dry type transformer

Anti-flash varnish finish, offering:

- Protection against corrosive environments
- Increase of electrical isolation
- High compression capacity
- Reduction of noise level
- Increase of product's lifespan

Metalic box IP-23 enclosure painted with epoxy polyester resin RAL 7035 (cat. C2 ISO 12994-2)

Safety class I

Includes electrostatic screen between primary and secondary terminals and bimetallic temperature sensor

Includes also lifting eyebolts from X VA

Possibility of tailor-made manufacturing

Downloads
