

Three-phase isolation transformers for medical use under IEC/EN 61558-2-15 standard, dry type with anti-flash varnish finished for maximum protection, insulation, noise and vibration reduction.



Technical characteristics

Rating	4000 VA
Input voltage	400 V
Output voltage	230 V
Frequency	50/60 Hz
Connection group	YNyn0
Protection degree	IP-00
Cooling	AN
Ambient temperature	45 °C
Inrush current	< 8In
Temperature rise	Class F - 155°C
Insulation	Class H - 180°C
Windings	Class HC - 200 °C
Test voltage	4,5 kV (1 min, 50 Hz)
No load voltage	< 3 %
Leakage current	0,5 mA (sec-earth)
Standards	IEC/EN/UNE-EN 61558-2-15, CE
Includes	Electrostatic screen between 1 ^o & 2 ^o and bimetal thermal protection
Weight	41 kg

Dimensions

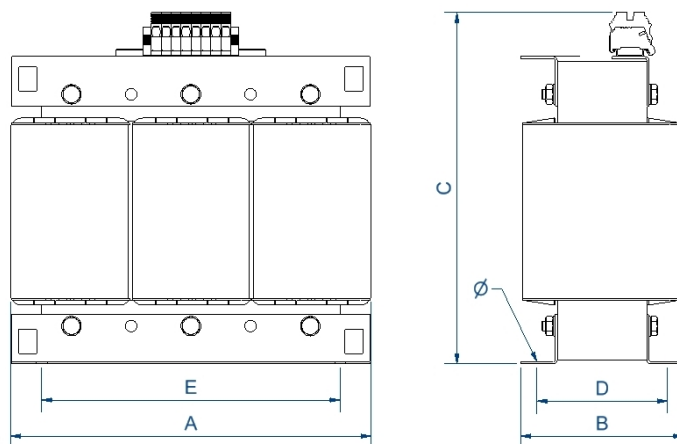

Dimensions (AxBxCxDxE): 300x164x303x155x250 mm 9Ø

Electrical connection

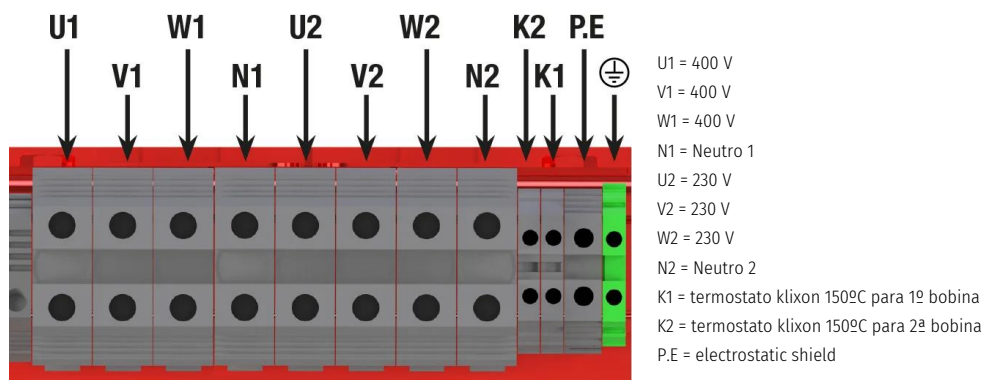

Three-phase isolation transformers for medical use under IEC/EN 61558-2-15 standard, dry type with anti-flash varnish finished for maximum protection, insulation, noise and vibration reduction.

Features

Dry type transformer

Anti-flash varnish finish, offering:

- Protection against corrosive environments
- Increase of electrical isolation
- High compression capacity
- Reduction of noise level
- Increase of product's lifespan

Safety class I

Includes electrostatic screen between primary and secondary terminals and bimetallic temperature sensor

Includes also lifting eyebolts from X VA

Possibility of tailor-made manufacturing

Downloads
