

Single phase dry type isolation transformers, finished in IP00 anti-flash varnished with protection to prevent direct contact with electrical parts.

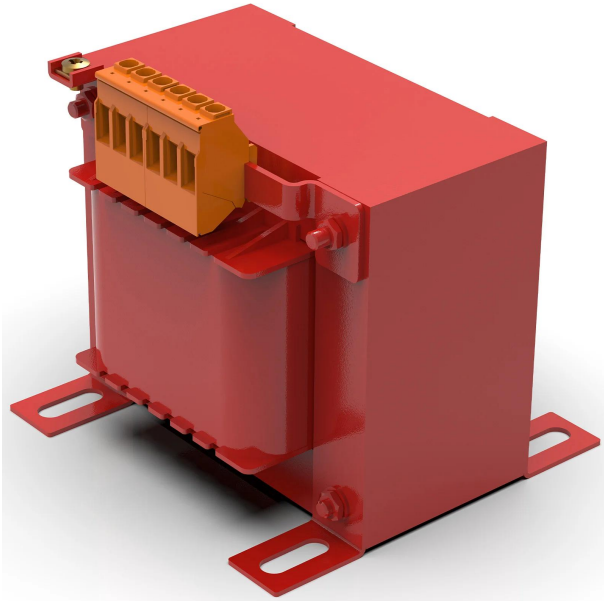

Technical characteristics

Rating	500 VA
Input voltage	15/0/15/230/400 V
Output voltage	230 V
Frequency	50/60 Hz
Protection degree	IP-00
Cooling	AN
Ambient temperature	45°C
Temperature rise	Class B - 130°C
Insulation	Class H - 180°C
Windings	Class HC - 200 °C
Test voltage	4,6 kV (1 min, 50 Hz) pri-sec - 3,2 kV (1 min, 50 Hz) pri-earth - 2,5 kV (1 min, 50 Hz) sec-earth
Standards	IEC/EN/UNE-EN 61558, CE
Mounting	Screws
Weight	5,3 kg

Electric scheme

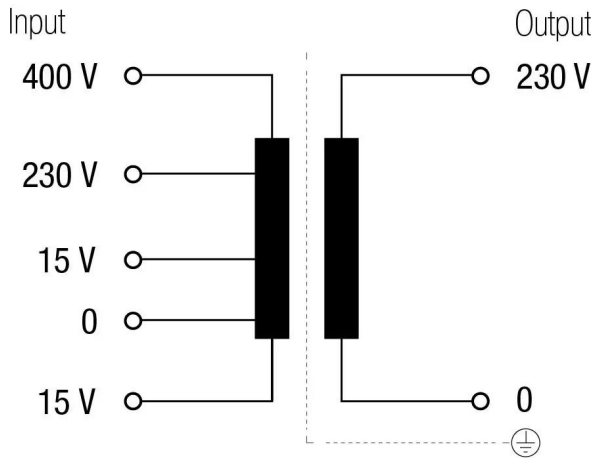

Dimensions

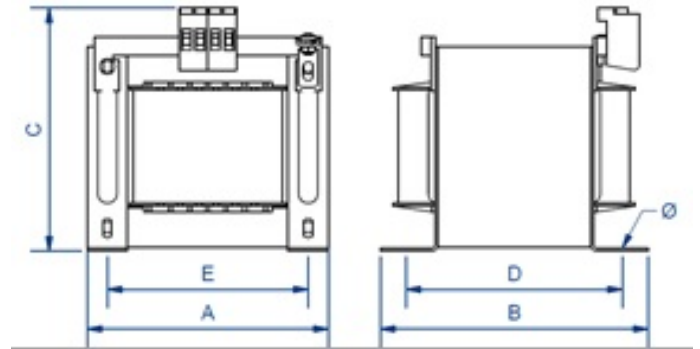

Dimensions (AxBxCxDxE): 126x110x115x75x106 mm 8

Electrical connection

1	2	3	4	5	6	7	
P/	15	0	15	230	400	S/ 0 230	V
POLYLUX		CE	50 - 60 Hz	IP-00			
Made in Spain			Ta40/B	EN 61558			
XXXX VA				PXRXXXX			
				S.N.:XXXXXX			

Input:		Output:
215 V	Connection: 3-4	230 V Connection: 6-7
230 V	Connection: 2-4	
245 V	Connection: 1-4	
400 V	Connection: 2-5	
385 V	Connection: 3-5	
415 V	Connection: 1-5	

Single phase dry type isolation transformers, finished in IP00 anti-flash varnished with protection to prevent direct contact with electrical parts.

Features

Dry type transformer (IP00)

Full rating in all taps.

Installation on DIN rail (up to 400VA) or by screws.

Custom made following the customer specifications.

Applications

- PXR transformers are specially designed to adapt voltages in switching and control applications in both domestic and industrial environments as well as in electrical cabinets.
- Another important application is the galvanic isolation of installations for safety reasons, as well as the generation of earth-referenced neutrals.
- We can also use them in installations where safety voltages are required (<50V).

Available accessories

Downloads
