

Single phase dry type ultra-isolation transformers, finished in anti-flash varnished in IP20 enclosure, resin filled with protection against direct contact with electrical parts and electrostatic screens (up to 1000 VA 1 screen or 800 VA 3 screens).



Technical characteristics

Rating	1600 VA
Input voltage	230 V
Output voltage	230 V
Electrostatic Screen	3 (80 dB attenuation at 10 kHz)
Frequency	50/60 Hz
Protection degree	IP-20
Cooling	ANAN
Ambient temperature	45°C
Temperature rise	Class B - 130°C
Insulation	Class H - 180°C
Windings	Class HC - 200 °C
Test voltage	4 kV (1 min, 50 Hz)
Standards	IEC/EN/UNE-EN 61558, CE
Mounting	Screws
Weight	37,6 kg

Electric scheme

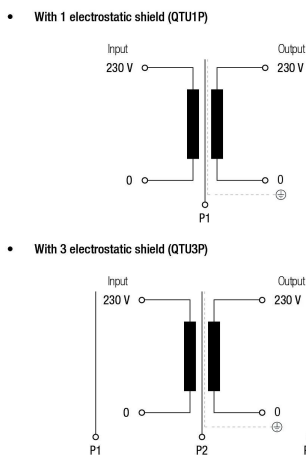

Dimensions

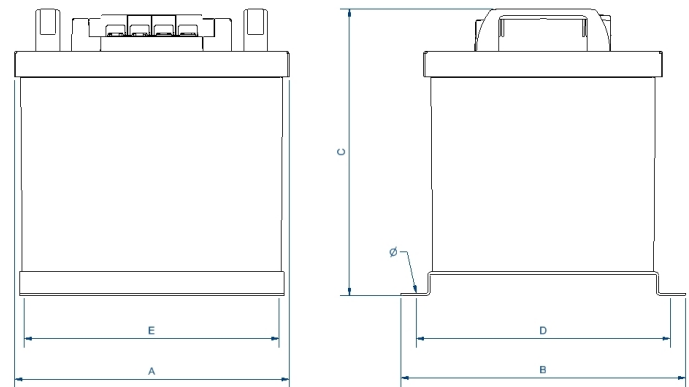

Dimensions (AxBxCxDxE): 233x241x314x219x175 mm 7Ø

Electrical connection



≥ 1000 VA

Input:
230 V

Connection: 2-3

Output:
230 V

Connection: 7-8

Electrostatic shield connection

QTU3P

Connection: 5 / 9 / 10

Single phase dry type ultra-isolation transformers, finished in anti-flash varnished in IP20 enclosure, resin filled with protection against direct contact with electrical parts and electrostatic screens (up to 1000 VA 1 screen or 800 VA 3 screens).

Features

Dry type resin cast transformer

Advantages of resin technology:

- Protection against corrosive environments
- Protection against high vibration levels
- Protection against electrodynamic efforts
- Reduction of noise level
- Increase of product's lifespan

IP-20 enclosure:

- Last generation V-0 fireproof polymer box according to UL94 until 1000 VA (PTU1P) or 800 VA (PTU3P)
- Resin from 1250 VA (QTU1P) or 1000 VA (QTU3P)

Safety class I, convertible in class II until 1000 VA (PTU1P) or 800 VA (PTU3P)

Includes LED functioning indicator and electrostatic screen (1 in PTU1P or 3 in PTU3P)

Possibility of tailor-made manufacturing

Downloads

- [Certificat CE](#)