

Three-phase line reactors for harmonic filtering with bimetal over-temperature protection resin finished and anti-flash varnished.

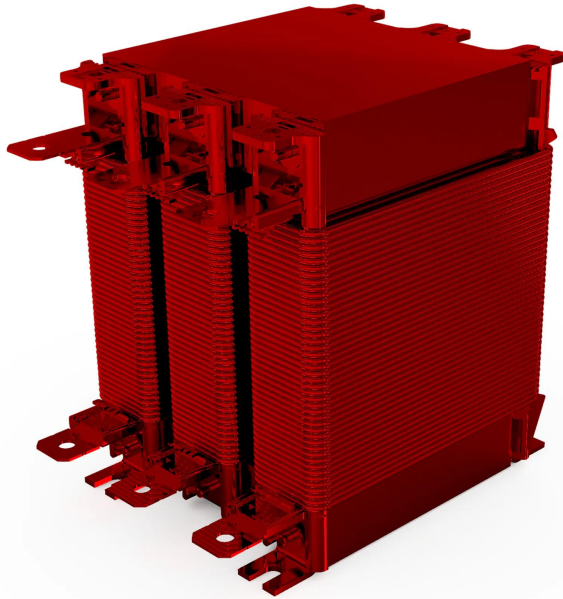

Technical characteristics

Rated current	1000 A
Motor rating	460-500kW / 625-680CV
Line voltage	380 - 460 V
Reactor	0,029 mH (50 Hz)
Voltage drop	4% (50 Hz)
Thermal overload factor	0,05
Frequency	50/60 Hz
Protection degree	IP-00
Cooling	AN
Ambient temperature	45 °C
Temperature rise	Class F - 155°C
Insulation	Clase H - 180 °C
Windings	Class HC - 200 °C
Test voltage	3 kV (1 min, 50 Hz)
Standards	IEC/EN/UNE-EN 60076-6, CE
Mounting	Screws
Includes	Bimetal thermal protection
Weight	185 kg

Electric scheme

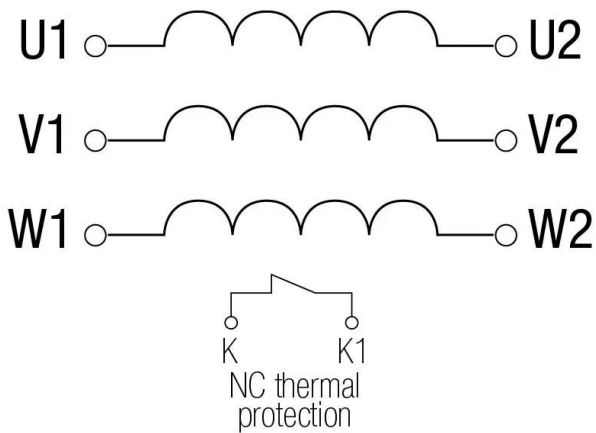

Dimensions

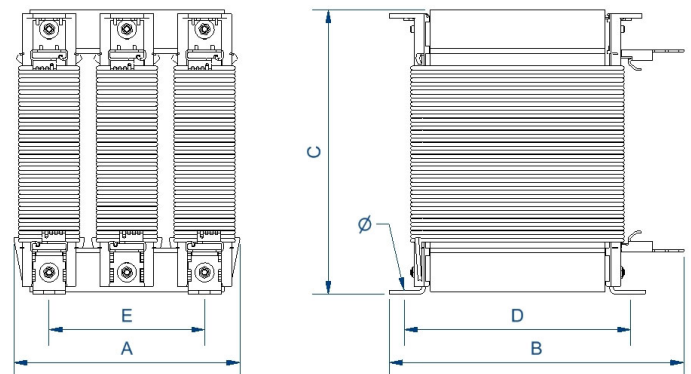

Dimensions (AxBxCxDxE): 370x380x600x304x140 mm 11Ø

Three-phase line reactors for harmonic filtering with bimetal over-temperature protection resin finished and anti-flash varnished.

Features

Reactor

Anti-flash varnish finish, offering:

- Protection against corrosive environments
- Increase of electrical isolation
- High compression capacity
- Reduction of noise level
- Increase of product's lifespan

Safety class I

Includes thermal protection against overtemperatures

Possibility of tailor-made manufacturing

Technical remarks about the use of line reactors:

- Reduction of the current harmonics generated by the equipment, reducing current consumption and improving power factor
- Reduction of the peak factor of the current wave, increasing equipment's lifespan
- Attenuation of the microcuts of the feeding voltage produced by the converter, source of the bad functioning of computers, robots and other equipments

Downloads
