

Single-phase dry-type isolation transformers finished in anti-flash varnished for maximum protection, insulation, noise and vibration reduction.

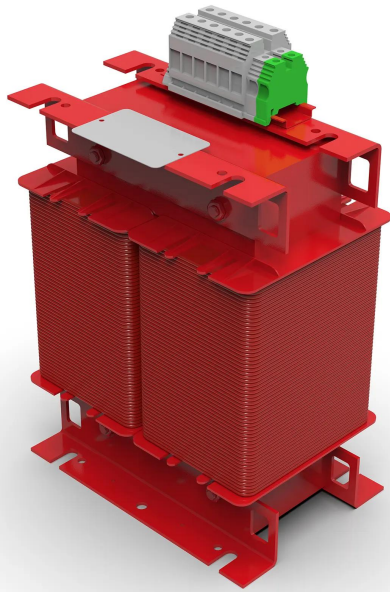

Technical characteristics

Rating	16 kVA
Input voltage	230 V
Output voltage	230 V
Frequency	50/60 Hz
Protection degree	IP-00
Cooling	AN
Ambient temperature	45 °C
Temperature rise	Class F - 155°C
Insulation	Class H - 180 °C
Windings	Class HC - 200 °C
Test voltage	3 kV (1 min, 50 Hz)
Standards	IEC/EN/UNE-EN 61558, CE
Weight	84 kg

Dimensions

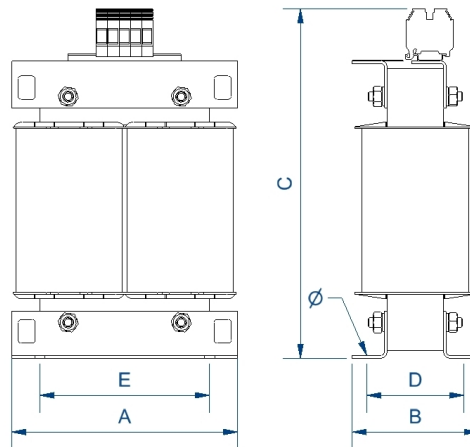

Dimensions (AxBxCxDxE): 320x214x465x146x240 mm 11Ø

Electrical connection

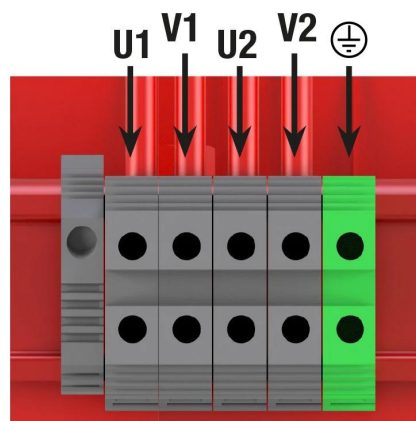

Single-phase dry-type isolation transformers finished in anti-flash varnished for maximum protection, insulation, noise and vibration reduction.

Features

Dry type transformer

Anti-flash varnish finish, offering:

- Protection against corrosive environments
- Increase of electrical isolation
- High compression capacity
- Reduction of noise level
- Increase of product's lifespan

Safety class I

Includes lifting eyebolts from >10 kVA

Possibility of tailor-made manufacturing

Applications

- TK transformers are used for the galvanic isolation of single-phase installations in the industrial and tertiary sectors for safety reasons.
- They are also used in the generation of ground referenced neutrals in high rating single-phase installations.
- On the other hand, in installations where there may be several earth leakages, TK transformers ensure supply by preventing the tripping of the main differential circuit breaker.
- To change the neutral regime of the installations, being able to go from a two-phase network to a single-phase network or vice versa (this case implies the generation of the artificial neutral).
- In installations where there may be small voltage peaks or with a certain level of electrical noise, the use of a transformer helps to improve the quality of the electrical network in its secondary.
- In outdoor installations where weather conditions are adverse, the TKZ version with IP-54 external enclosure offers an optimal solution.

Available accessories

- PT100 probe.
- PTC probe.
- Bimetallic probe.
- Temperature control unit

Downloads

- [Obtaining a neutral - Bridge configuration TK \(PH+N output\).](#)
- [Installation and maintenance manual.](#)
- [CE Certificate.](#)