

Single-phase cast resin transformer rectifiers with 48% dry type ripple, IP20 with protection to prevent direct contact with electrical parts.

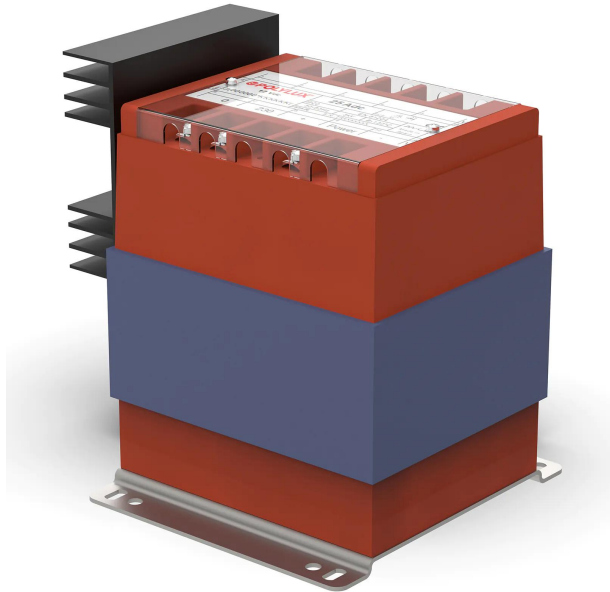

Technical characteristics

Rating	16 Adc
Input voltage	230 Vac
Output voltage	24 Vdc
Output ripple	48%
Frequency	50/60 Hz
Protection degree	IP-20
Cooling	AN
Ambient temperature	45 °C
Temperature rise	Class B - 130°C
Insulation	Class H - 180°C
Windings	Class HC - 200 °C
Test voltage	3 kV (1 min, 50 Hz) pri-sec 3 kV (1 min, 50 Hz) pri-earth 0,5 kV (1 min, 50 Hz) sec-earth
Standards	IEC/EN/UNE-EN 61204, CE
Mounting	Screws
Weight	7,4 kg

Electric scheme

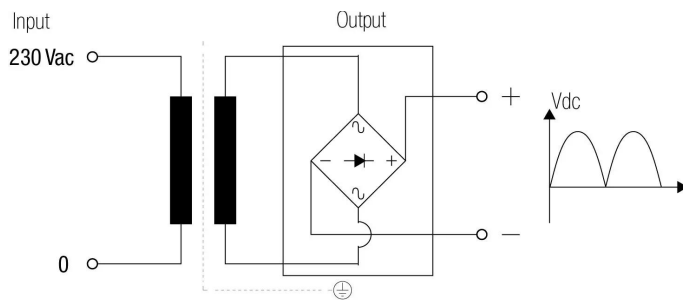

Dimensions

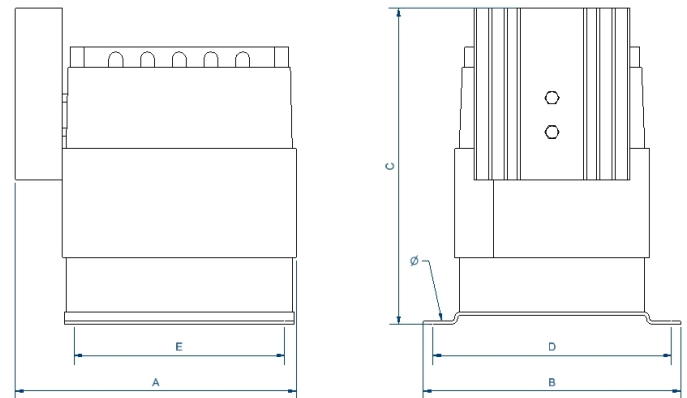

Dimensions (AxBxCxDxE): 167x145x191 mm 7Ø

Single-phase cast resin transformer rectifiers with 48% dry type ripple, IP20 with protection to prevent direct contact with electrical parts.

Features

Rectifier transformer dry type encapsulated in resin:

- Protection against corrosive environments.
- Protection against high levels of vibrations.
- Protection against electrodynamic efforts.
- Reduction of the noise level.
- Increase of the useful life of the product.

Safety class I.

Includes LED operation indicator and fuse starting at 300W.

DIN rail or screw fixing for: TRA1,6, TRA2,5, TRB1,6 and TRB2,5.

Possibility of custom manufacturing if the standard specifications are not required.

Applications

- TR rectifier transformers are used in applications where loads require DC power and they can operate with ripple voltage of approximately 5%.

Available accessories

Available accessories

- Fuse in primary

Downloads
