

Single-phase cast resin transformer rectifiers with 5% dry type ripple, IP20 with protection to prevent direct contact with electrical parts.

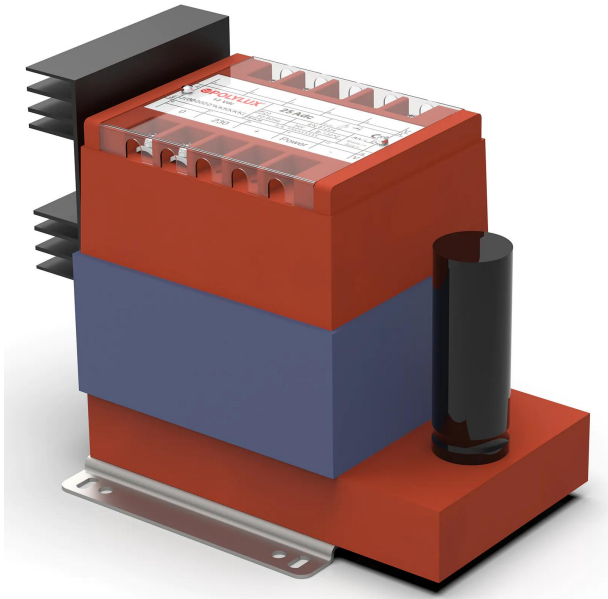

Technical characteristics

Rating	16 Adc
Input voltage	230 Vac
Output voltage	12 Vdc
Output ripple	5%
Frequency	50/60 Hz
Protection degree	IP-20
Cooling	AN
Ambient temperature	45 °C
Temperature rise	Class B - 130°C
Insulation	Class H - 180°C
Windings	Class HC - 200 °C
Test voltage	3 kV (1 min, 50 Hz) pri-sec 3 kV (1 min, 50 Hz) pri-earth 0,5 kV (1 min, 50 Hz) sec-earth
Standards	IEC/EN/UNE-EN 61204, CE
Mounting	Screws
Weight	5,4 kg

Electric scheme

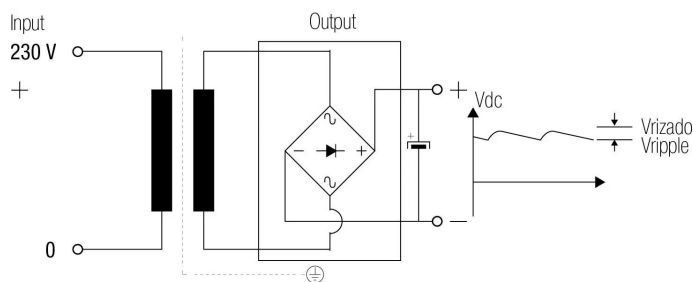

Dimensions

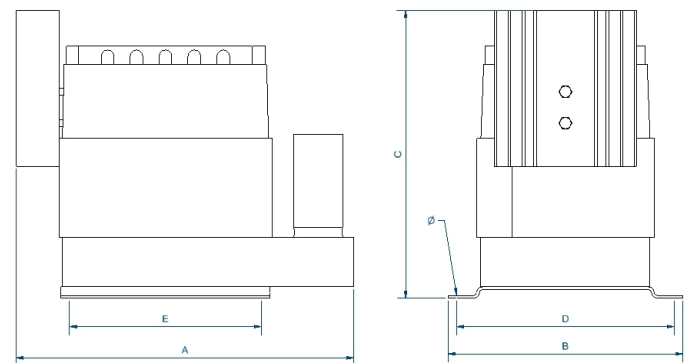

Dimensions (AxBxCxDxE): 202x122x185 mm 6Ø

Single-phase cast resin transformer rectifiers with 5% dry type ripple, IP20 with protection to prevent direct contact with electrical parts.

Features

Rectifier transformer dry type encapsulated in resin with filter output:

- Protection against corrosive environments.
- Protection against high levels of vibrations.
- Protection against electrodynamic efforts.
- Reduction of the noise level.
- Increase of the useful life of the product.

Safety class I.

Includes LED operation indicator and fuse starting at 300W.

Possibility of custom manufacturing if the standard specifications are not required.

Ripple voltage of approximately 5%

Applications

- TRF rectifier transformers are used in applications where loads require DC power.

Available accessories

Available accessories

- Fuse in primary

Downloads
