

Three-phase cast resin encapsulated three-phase rectifier transformer rectifiers for control, dry type, IP20 with protection to prevent direct contact with electrical parts.

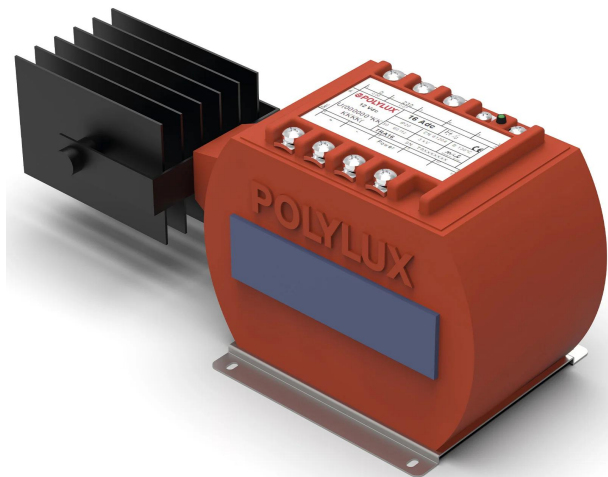

Technical characteristics

Rating	10 Adc
Input voltage	400 Vac
Output voltage	24 Vdc
Output ripple	0,04
Frequency	50/60 Hz
Protection degree	IP-20
Cooling	AN
Ambient temperature	45 °C
Temperature rise	Class F - 155°C
Insulation	Class H - 180°C
Windings	Class HC - 200 °C
Test voltage	3 kV (1 min, 50 Hz) pri-sec - 3 kV (1 min, 50 Hz) pri-earth - 0,5 kV (1 min, 50 Hz) sec-earth
Standards	IEC/EN/UNE-EN 61204, CE
Mounting	Screws
Weight	9,3 kg

Dimensions

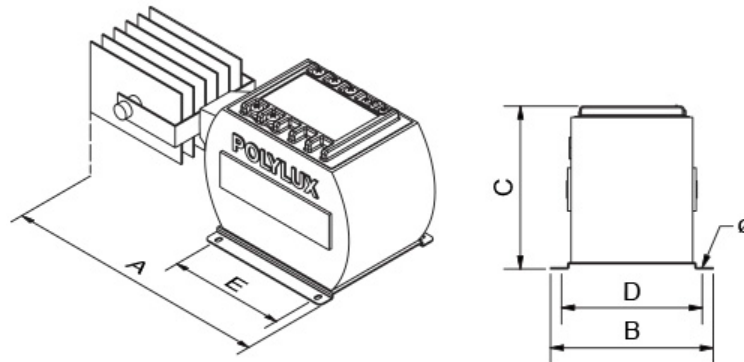

Dimensions (AxBxCxDxE): 205x147x165x126x103 mm 7Ø

Three-phase cast resin encapsulated three-phase rectifier transformer rectifiers for control, dry type, IP20 with protection to prevent direct contact with electrical parts.

Features

Dry type resin cast transformer

Advantages of resin technology:

- Protection against corrosive environments
- Protection against high vibration levels
- Protection against electrodynamic efforts
- Reduction of noise level
- Increase of product's lifespan

Safety class I

Includes LED functioning indicator and thermal protection against overtemperatures

Possibility of tailor-made manufacturing

Downloads
