

Three-phase cast resin encapsulated three-phase rectifier transformer rectifiers for control, dry type, IP20 with protection to prevent direct contact with electrical parts.



Technical characteristics

Rating	100 Adc
Input voltage	400 Vac
Output voltage	24 Vdc
Output ripple	0,04
Frequency	50/60 Hz
Protection degree	IP-20
Cooling	AN
Ambient temperature	45 °C
Temperature rise	Class F - 155°C
Insulation	Class H - 180°C
Windings	Class HC - 200 °C
Test voltage	3 kV (1 min, 50 Hz) pri-sec - 3 kV (1 min, 50 Hz) pri-earth - 0,5 kV (1 min, 50 Hz) sec-earth
Standards	IEC/EN/UNE-EN 61204, CE
Mounting	Screws
Weight	49,3 kg

Dimensions

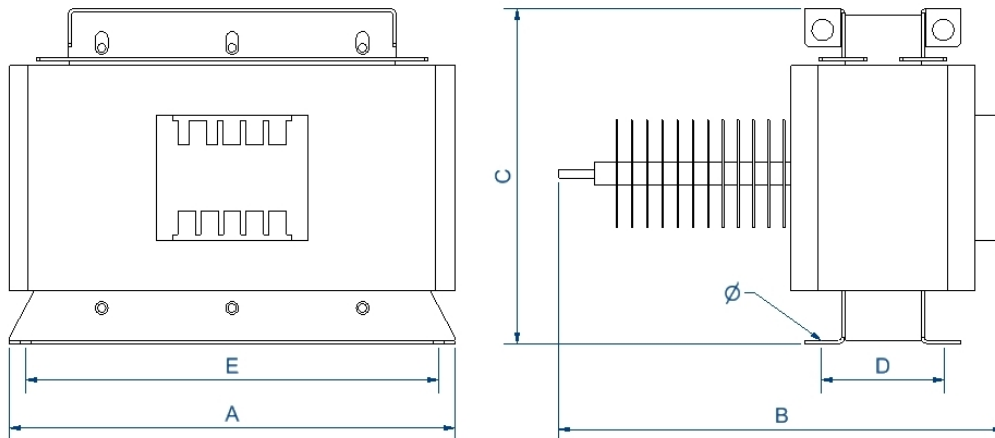

Dimensions (AxBxCxDxE): 340x470x255x126x310 mm 9∅

Three-phase cast resin encapsulated three-phase rectifier transformer rectifiers for control, dry type, IP20 with protection to prevent direct contact with electrical parts.

Features

Dry type resin cast transformer

Advantages of resin technology:

- Protection against corrosive environments
- Protection against high vibration levels
- Protection against electrodynamic efforts
- Reduction of noise level
- Increase of product's lifespan

Safety class I

Includes LED functioning indicator and thermal protection against overtemperatures

Possibility of tailor-made manufacturing

Downloads
