

Three-phase dry type cast resin isolation transformers for high corrosion and vibration environments.



Technical characteristics

Rating	315 kVA
Input voltage	400 V
Output voltage	400 V
Frequency	50/60 Hz
Connection group	Yyn0
Protection degree	IP-00
Cooling	AN
Ambient temperature	45 °C
Temperature rise	Class H - 180°C
Insulation	Class H - 180°C
Windings	Class HC - 200 °C
Test voltage	3 kV (1 min, 50 Hz)
Standards	IEC/EN/UNE-EN 60076, CE
Weight	1429 kg

Dimensions

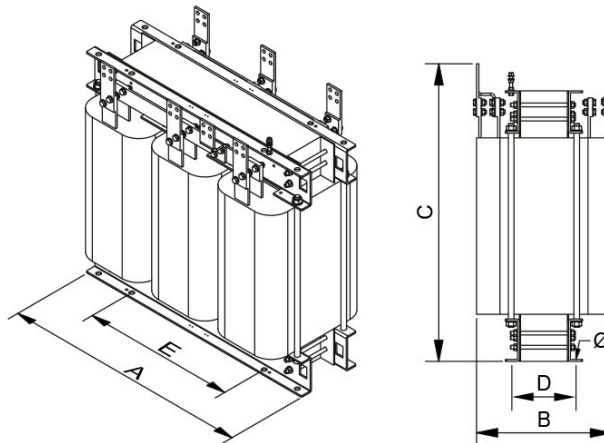

Dimensions (AxBxCxDxE): 1083x550x1205x460x690 mm 13Ø

Features

Dry type resin cast transformer

Advantages of resin technology::

- Protection against corrosive environments.
- Protection against high vibration levels.
- Protection against electrodynamic efforts.
- Reduction of noise level.
- Increase of product's lifespan

Safety class I.

Includes lifting eyebolts from 6,3 kVA.

Possibility of tailor-made manufacturing.

Applications

- TT transformers are used for insulation galvanic three-phase installations for reasons of security.
- They are also used in the generation of neutrals referenced to ground in single-phase installations of high power.
- In facilities where there may be small peaks of voltage or noise, the TT transformers help improve the quality of the signal that feeds the charges.
- On the other hand in facilities where there may be several leakage to ground, TT transformers ensure the supply avoiding the tripping of the differential switch general.

Available accessoires

- Protections in primary and secondary.
- One, two and up to 3 electrostatic screens.
- Class II
- Wheels.
- PT100, PTC or Bimetallic probes.
- Painting C5.
- Different RAL.
- Temperature control unit
- Anti condensation system
- Different IP up to IP-65

CE Certificate

- [CE certificate.](#)