

Three-phase isolation transformers for installations with a 60% harmonic level. Dry type k20 factor with anti-flash varnish finished for maximum protection, insulation, noise and vibration reduction.



Technical characteristics

Rating	250 kVA
Input voltage	400 V
Output voltage	400 V
Frequency	50/60 Hz
k Factor	20
THDI (<=)	0,9
Connection group	Dyn11
Protection degree	IP-00
Cooling	AN
Ambient temperature	45 °C
Temperature rise	Class H - 180°C
Insulation	Class H - 180°C
Windings	Class HC - 200 °C
Test voltage	3 kV (1 min, 50 Hz)
Standards	IEC/EN/UNE-EN 60076, CE
Weight	1176 kg

Dimensions

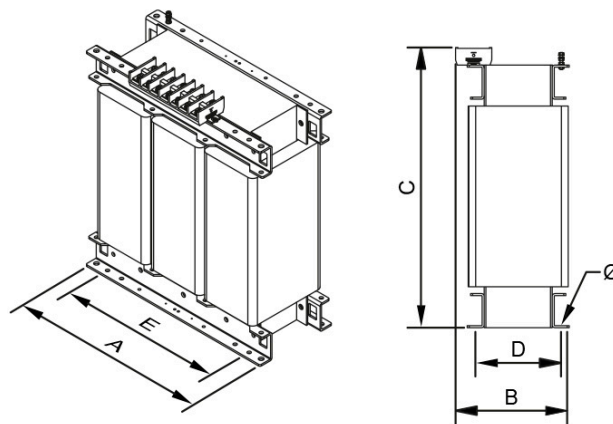

Dimensions (AxBxCxDxE): 1070x550x1220x460x690 mm 17Ø

Electrical connection

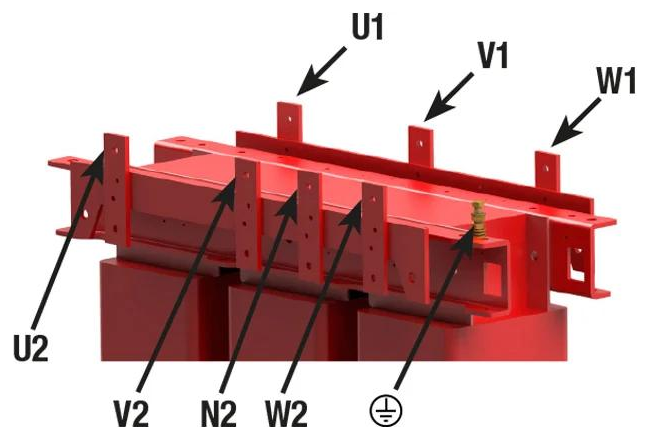
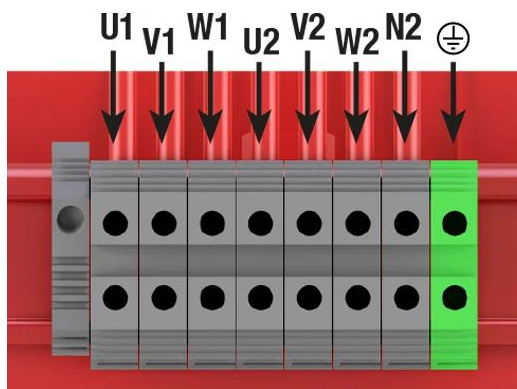

Three-phase isolation transformers for installations with a 60% harmonic level. Dry type k20 factor with anti-flash varnish finished for maximum protection, insulation, noise and vibration reduction.

Features

Dry type transformer

Anti-flash varnish finish, offering:

- Protection against corrosive environments
- Increase of electrical isolation
- High compression capacity
- Reduction of noise level
- Increase of product's lifespan

Safety class I

Neutral sized for 2 x In

K factor = 20

Includes lifting eyebolts

Possibility of tailor-made manufacturing

Downloads
