

Three-phase isolation transformers for installations with a 30% harmonic level. Dry type k13 factor finished in anti-flash varnished in IP23 metal enclosure with protection to prevent direct contact with electrical parts.



Technical characteristics

Rating	100 kVA
Input voltage	400 V
Output voltage	400 V
Frequency	50/60 Hz
k Factor	13
Cover	Metal enclosure RAL 7035 (cat. C3 ISO 12994-2)
THDI (<=)	0,6
Connection group	Dyn11
Protection degree	IP-23 / IK-08
Cooling	ANAN
Ambient temperature	45 °C
Temperature rise	Class H - 180°C
Insulation	Class H - 180°C
Windings	Class HC - 200 °C
Test voltage	3 kV (1 min, 50 Hz)
Standards	IEC/EN/UNE-EN 60076, CE
Weight	493 kg

Dimensions

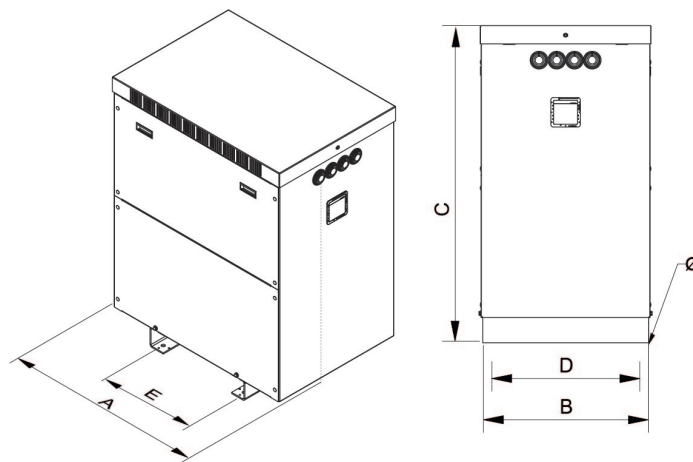

Dimensions (AxBxCxDxE): 970x670x1250x582x470 mm 18Ø

Electrical connection

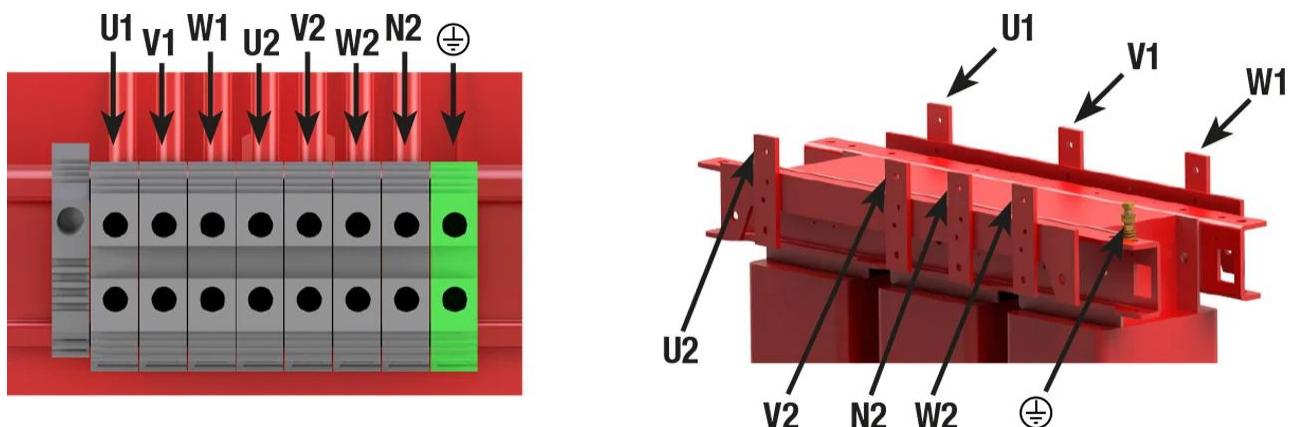

Three-phase isolation transformers for installations with a 30% harmonic level. Dry type k13 factor finished in anti-flash varnished in IP23 metal enclosure with protection to prevent direct contact with electrical parts.

Features

Dry type transformer

Anti-flash varnish finish, offering:

- Protection against corrosive environments
- Increase of electrical isolation
- High compression capacity
- Reduction of noise level
- Increase of product's lifespan

IP-23 metallic box enclosure painted with epoxy polyester resin RAL 7035 (cat. C2 ISO 12994-2)

Safety class I

Neutral sized for $2 \times I_n$

Factor $K = 13$

Includes lifting eyebolts

Possibility of tailor-made manufacturing

Downloads
