

Three-phase isolation transformers for dry type solar inverters, finished in anti-flash varnished in IP23 metal enclosure with protection to prevent direct contact with electrical parts.



Technical characteristics

Rating	1 kVA
Input voltage	800 V
Output voltage	400 V
Frequency	50/60 Hz
Connection group	YNyn0
Cover	Metal enclosure RAL 7035 (cat. C3 ISO 12994-2)
Protection degree	IP-23 / IK-08
Cooling	ANAN
Ambient temperature	45 °C
Temperature rise	Class F
Insulation	Class F - 155°C
Windings	Class HC - 200 °C
Efficiency (%)	90,5
Noise level (dB)	< 45
Test voltage	3 kV (1 min, 50 Hz)
Standards	IEC/EN/UNE-EN 61558, CE
Weight	13,2 kg

Dimensions

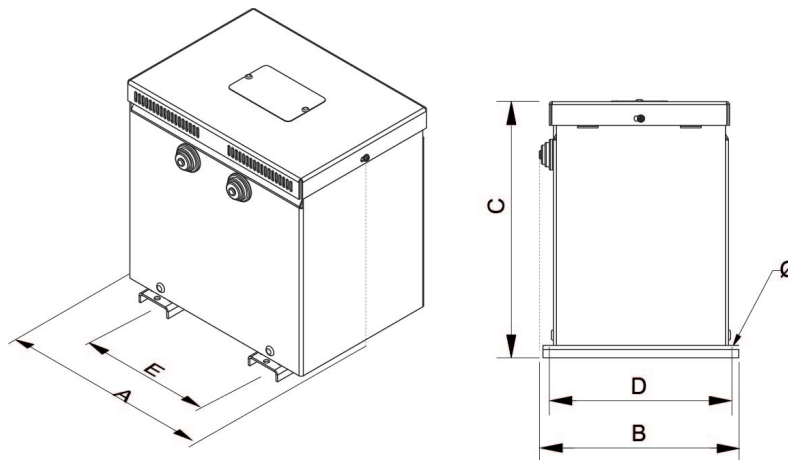

Dimensions (AxBxCxDxE): 240x190x250x180x150 mm 6

Three-phase isolation transformers for dry type solar inverters, finished in anti-flash varnished in IP23 metal enclosure with protection to prevent direct contact with electrical parts.

Features

Dry type transformer.

All transformers are tropicalized with anti-flash varnish:

- Protection against corrosive environments.
- Greater electrical insulation.
- High compaction power.
- Noise level reduction.
- Longer life span of the product.
- (IP-23 enclosure, metal box painted with RAL 7035 polyester resin (cat. C4 ISO 12994-2).)

Lifting bolts from 10kVA.

Tailor made, if the standard specifications are not what is required.

Applications

- TTF transformers are used for galvanic isolation of three-phase solar installations.
- They are also used in the generation of ground-referenced neutrals.

Available accessories

- One, two and up to three electrostatic screens.
- Class II.
- Wheel
- PT100, PTC or Bimetallic probes.
- C5 paint.
- Several RAL
- Electric temperature panel.
- Anti-condensation system.
- IP up to IP-65.

Downloads

Certification