

Three-phase isolation transformers for dry type solar inverters with anti-flash varnish finished for maximum protection, insulation, noise and vibration reduction.



Technical characteristics

Rating	800 kVA
Input voltage	800 V
Output voltage	400 V
Frequency	50/60 Hz
Connection group	YNyn0
Protection degree	IP-00
Cooling	AN
Ambient temperature	45 °C
Temperature rise	Class H - 180°C
Insulation	Class H - 180°C
Windings	Class HC - 200 °C
Efficiency (%)	98,8
Noise level (dB)	< 65
Test voltage	3 kV (1 min, 50 Hz)
Standards	IEC/EN/UNE-EN 60076, CE
Weight	2413 kg

Dimensions

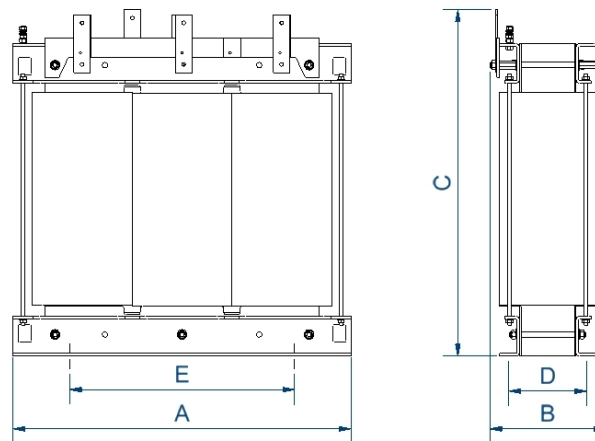

Dimensions (AxBxCxDxE): 1300x700x1350x600x800 mm 17

Three-phase isolation transformers for dry type solar inverters with anti-flash varnish finished for maximum protection, insulation, noise and vibration reduction.

Features

Dry type transformer.

All transformers are tropicalized with anti-flash varnish:

- Protection against corrosive environments.
- Greater electrical insulation.
- High compaction power.
- Noise level reduction.
- Longer useful life of the product.

Lifting bolts from 10kVA.

Tailor made, if the standard specifications are not what is required.

Applications

- TTF transformers are used for galvanic isolation of three-phase solar installations.
- They are also used in the generation of ground-referenced neutrals.

Available accessories

Available accessories

- One, two and up to three electrostatic screens.
- Class II.
- Wheel
- PT100, PTC or Bimetallic probes.
- C5 paint.
- Several RAL
- Electric temperature panel.
- Anti-condensation system.
- IP up to IP-65.

Downloads

Certificates