

Three-phase dry type ecological isolation transformers with high performance finished in anti-flash varnished in IP23 metal enclosure with protection to prevent direct contact with electrical parts.



Technical characteristics

Rating	250 kVA
Input voltage	400 V
Output voltage	400 V
Frequency	50/60 Hz
Connection group	Yyn0
Cover	Metal enclosure RAL 7035 (cat. C3 ISO 12994-2)
Protection degree	IP-23/IK-08
Cooling	ANAN
Ambient temperature	45°C
Temperature rise	Class H - 180°C
Insulation	Class H - 180°C
Windings	Class HC - 200 °C
Inrush current	< 8In
Voltage drop	< 2 %
Efficiency (%)	98,7
Noise level (dB)	< 65
Test voltage	3 kV (1 min, 50 Hz)
Standards	IEC/EN/UNE-EN 60076, CE
Weight	924 kg

Dimensions

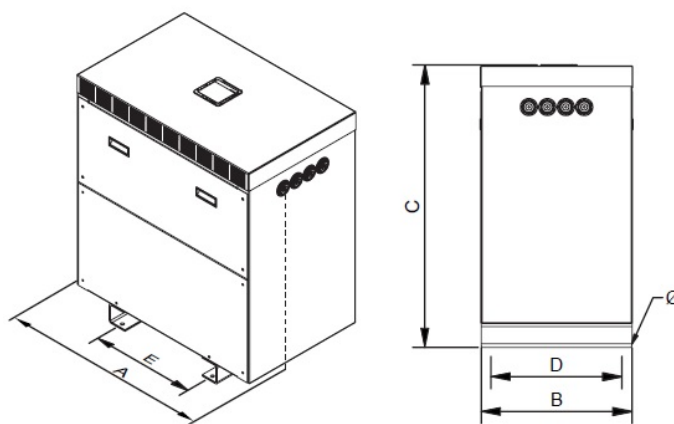

Dimensions (AxBxCxDxE): 1200x760x1555x672x690 mm 18Ø

Three-phase dry type ecological isolation transformers with high performance finished in anti-flash varnished in IP23 metal enclosure with protection to prevent direct contact with electrical parts.

Features

Dry type transformer

All transformers are dipped in anti-flash varnish for increased insulation and compactness.

Reduces long-term operating costs.

Low temperature rise.

Longer life than standard transformers.

Prepared for higher ambient temperatures.

Low connection peak.