

Three-phase to single-phase dry-type isolation transformers finished in anti-flash varnished for maximum protection, insulation, noise and vibration reduction.

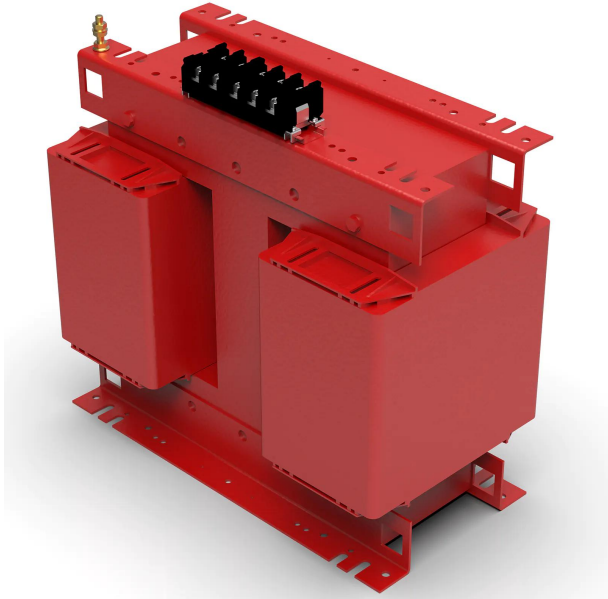

Technical characteristics

Rating	31,5 kVA
Input voltage	400 V
Output voltage	230 V
Frequency	50/60 Hz
Connection group	V/ inV
Protection degree	IP-00
Cooling	AN
Ambient temperature	45 °C
Temperature rise	Class F - 155°C
Insulation	Class H - 180°C
Windings	Class HC - 200 °C
Test voltage	3 kV (1 min, 50 Hz)
Standards	IEC/EN/UNE-EN 60076, CE
Weight	234 kg

Dimensions

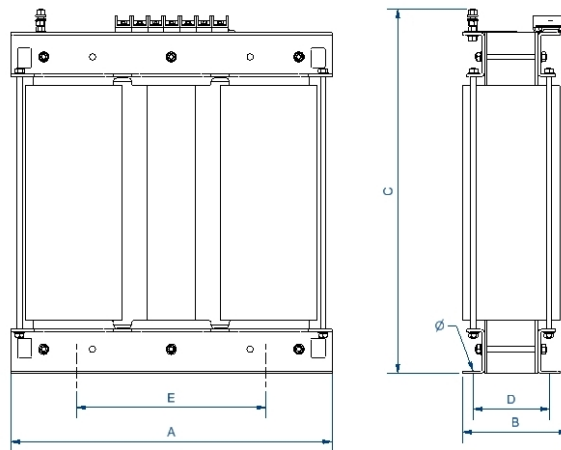

Dimensions (AxBxCxDxE): 740x310x580x190x426 mm 13Ø

Electrical connection

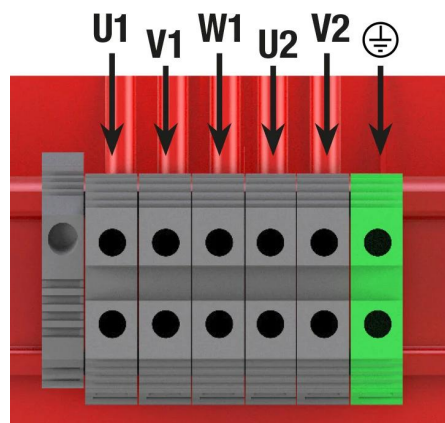

Three-phase to single-phase dry-type isolation transformers finished in anti-flash varnished for maximum protection, insulation, noise and vibration reduction.

Features

Dry type transformer

Dipped in anti-flash varnish and then compacted in the oven. This process increases the insulation grade, reduces noise and provides anti-moisture, waterproofed protection.

Inverted V/v connection.

Includes lifting eyebolts

Possibility of tailor-made manufacturing

Applications

- TTK transformers are used for the galvanic isolation of electrical installations for safety reasons.
- The TTK series with three-phase input and single-phase output are used to achieve a better balance of the primary currents than by connecting only one phase and one neutral of a three-phase line.
- With the three-phase transformer it is also possible to connect a single load of up to half the mains rating.
- In installations where many single-phase loads have to be connected to the same line, the three-phase transformer can also help to make more rating available on that line.

Available accessories

- Protections in primary and secondary.
- One, two and up to 3 electrostatic screens.
- Class II
- Wheels.
- PT100, PTC or Bimetallic probes.
- Painting C5.
- Different RAL.
- Temperature control unit
- Anti condensation system
- Different IP up to IP-65

CE certificate

- **Certificado CE.**